

IPC Accessories Installation Guide

2019-08-28

Box camera mount

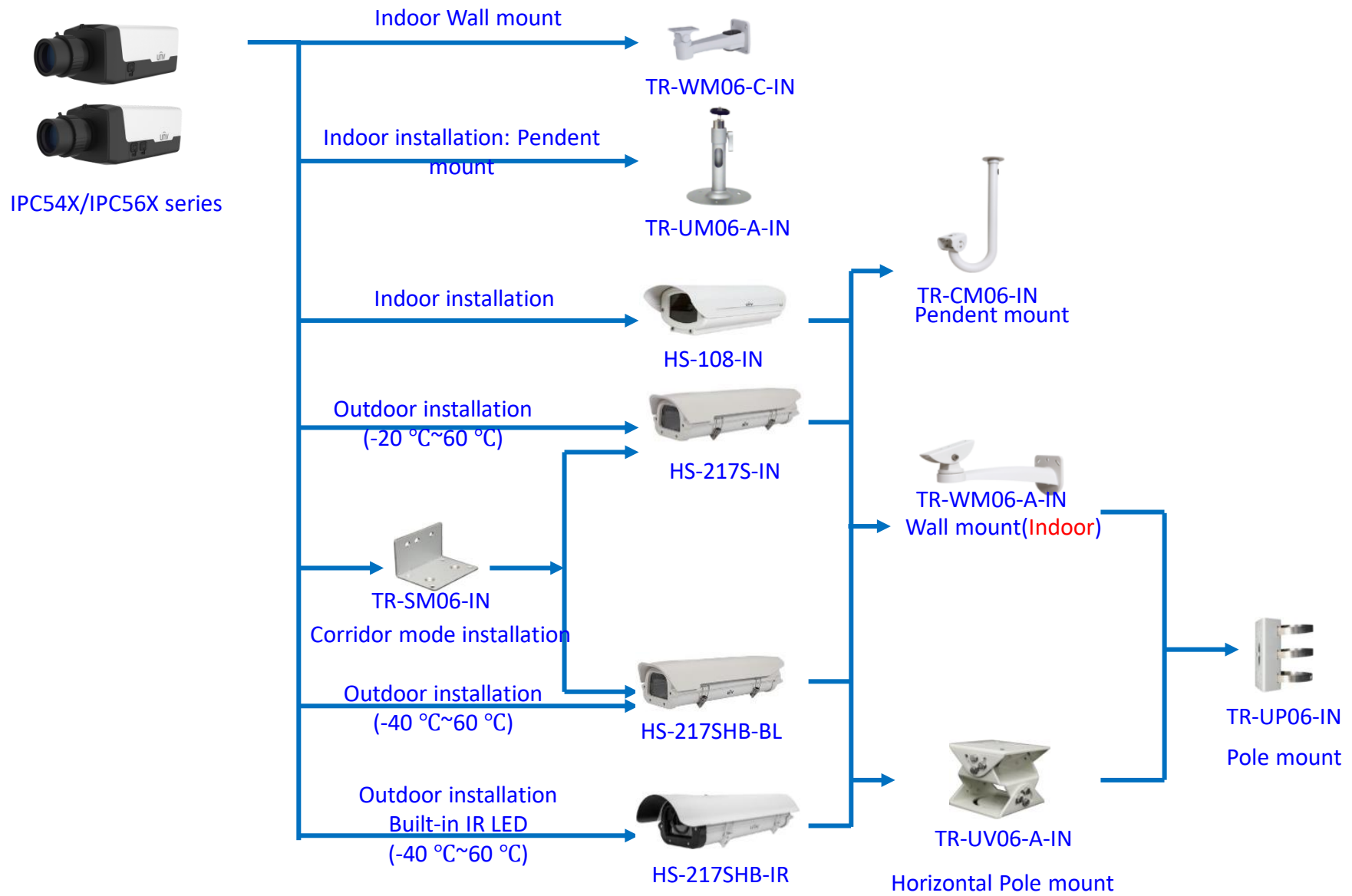

Box camera mount



IPC54X/IPC56X series

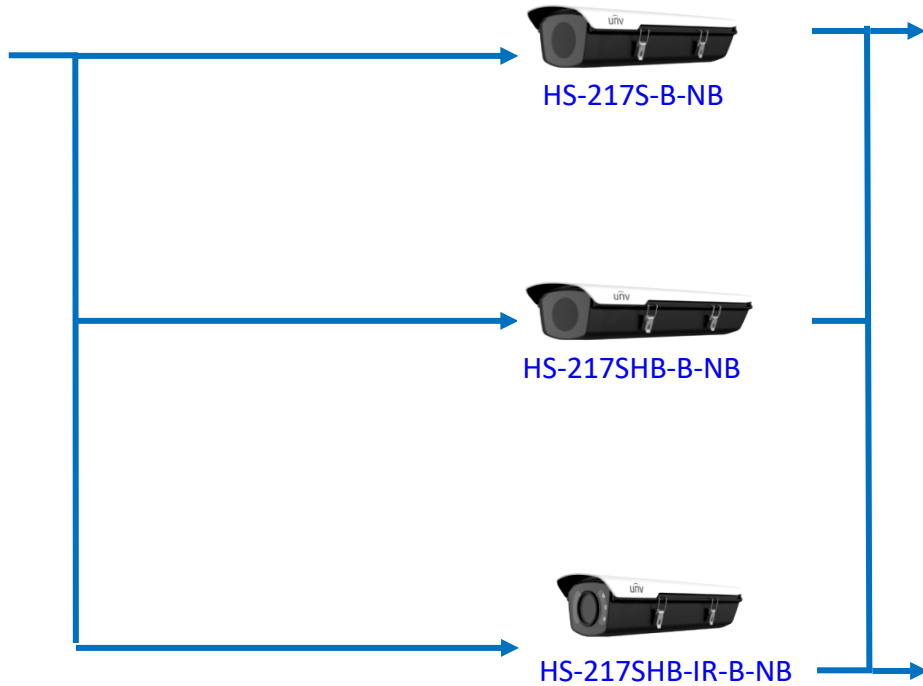

HS-217S-B-NB



HS-217SHB-B-NB



HS-217SHB-IR-B-NB



TR-WM06-I-IN
Wall mount



TR-UV06-A-IN
Horizontal Pole
mount



TR-UP06-IN
Pole mount

Dome camera mount

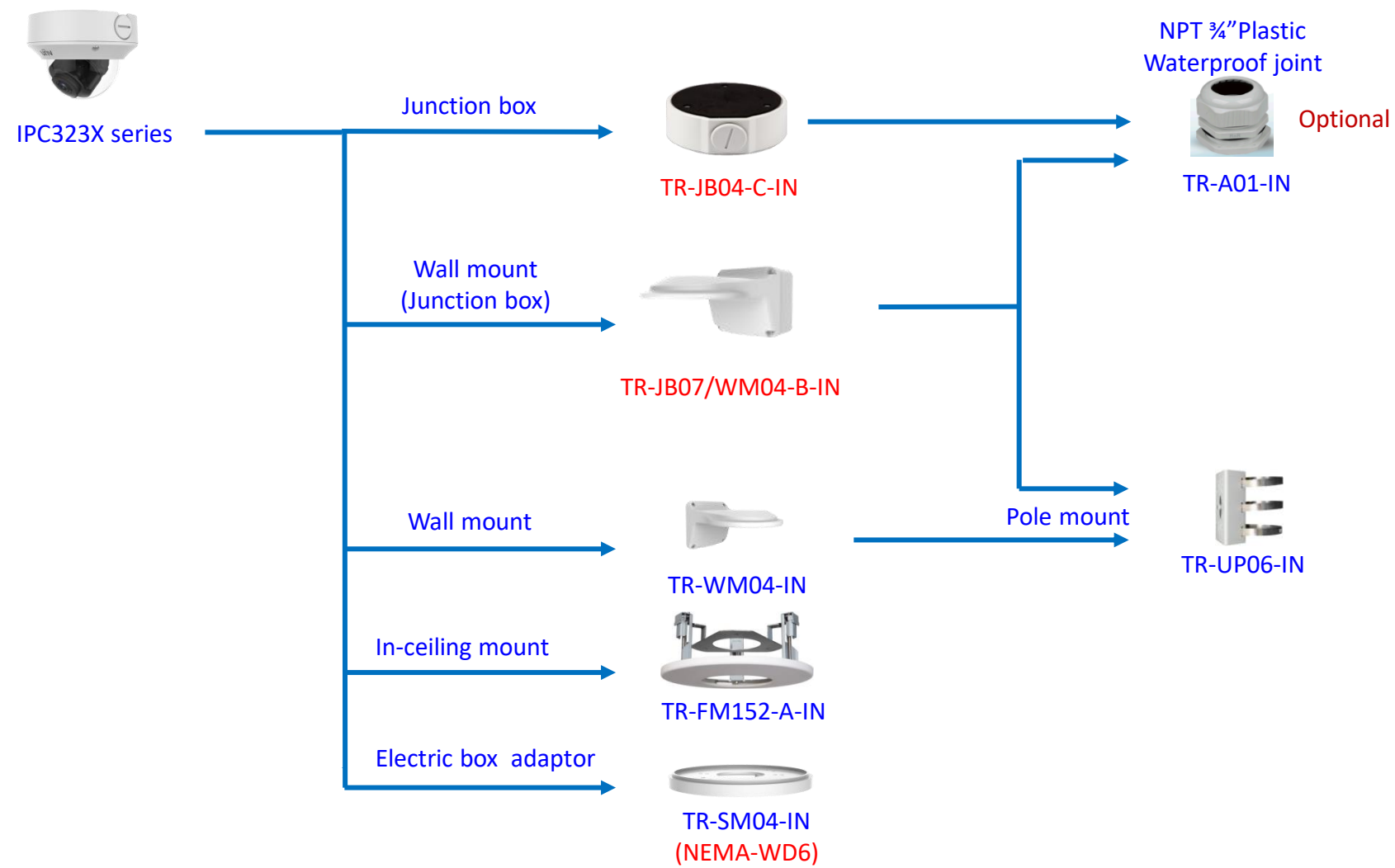

Dome camera mount

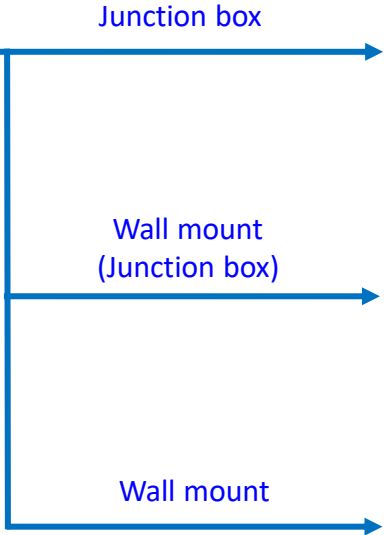

TR-JB03-H-IN



TR-JB07/WM03-F-IN



TR-WM03-B-IN

NPT 3/4" Plastic
Waterproof joint



Optional

TR-A01-IN

Pole mount



TR-UP06-IN



EASY series
IPC361XL

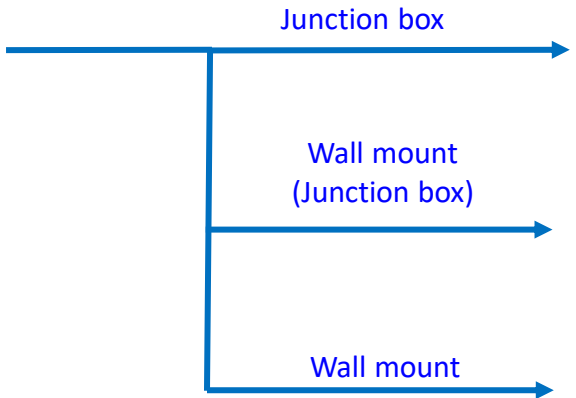

TR-JB03-I-IN



TR-JB07/WM03-G-IN



TR-WM03-D-IN

NPT 3/4" Plastic
Waterproof joint



Optional

TR-A01-IN

Pole mount



TR-UP06-IN

Dome camera mount

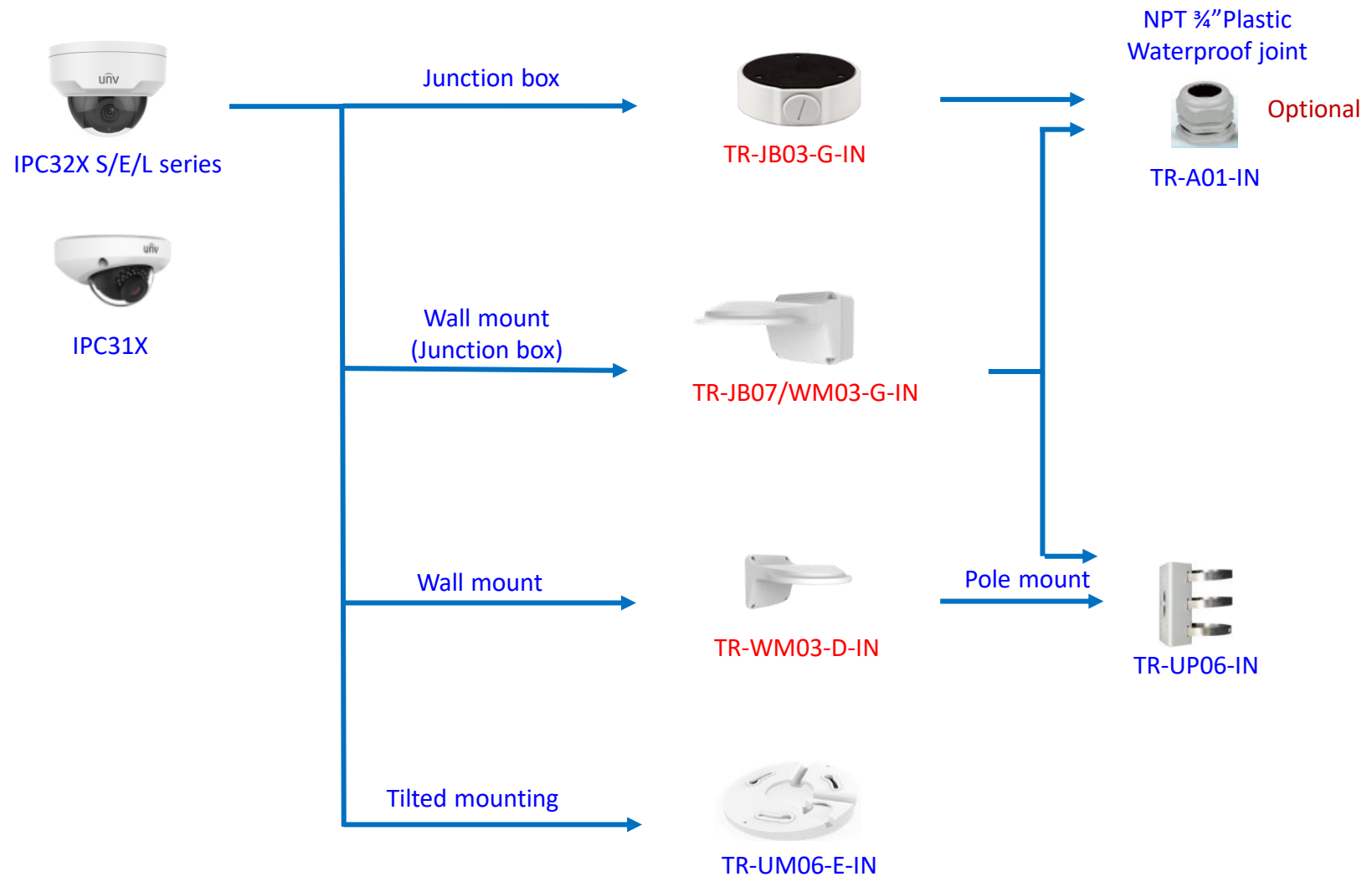

Fisheye camera mount



Dome camera Indoor pendent mount

*Release: 2019Q1



Junction box

- IPC323X series + TR-JB04-C-IN
- PRIME series IPC363X + TR-JB03-H-IN
- PRIME series IPC361X S/E
- EASY series IPC361XL + TR-JB03-I-IN
- IPC32X S/E/L series IPC31X + TR-JB03-G-IN
- 868 fisheye + TR-JB04-D-IN
- 814 fisheye + TR-JB03-H-IN

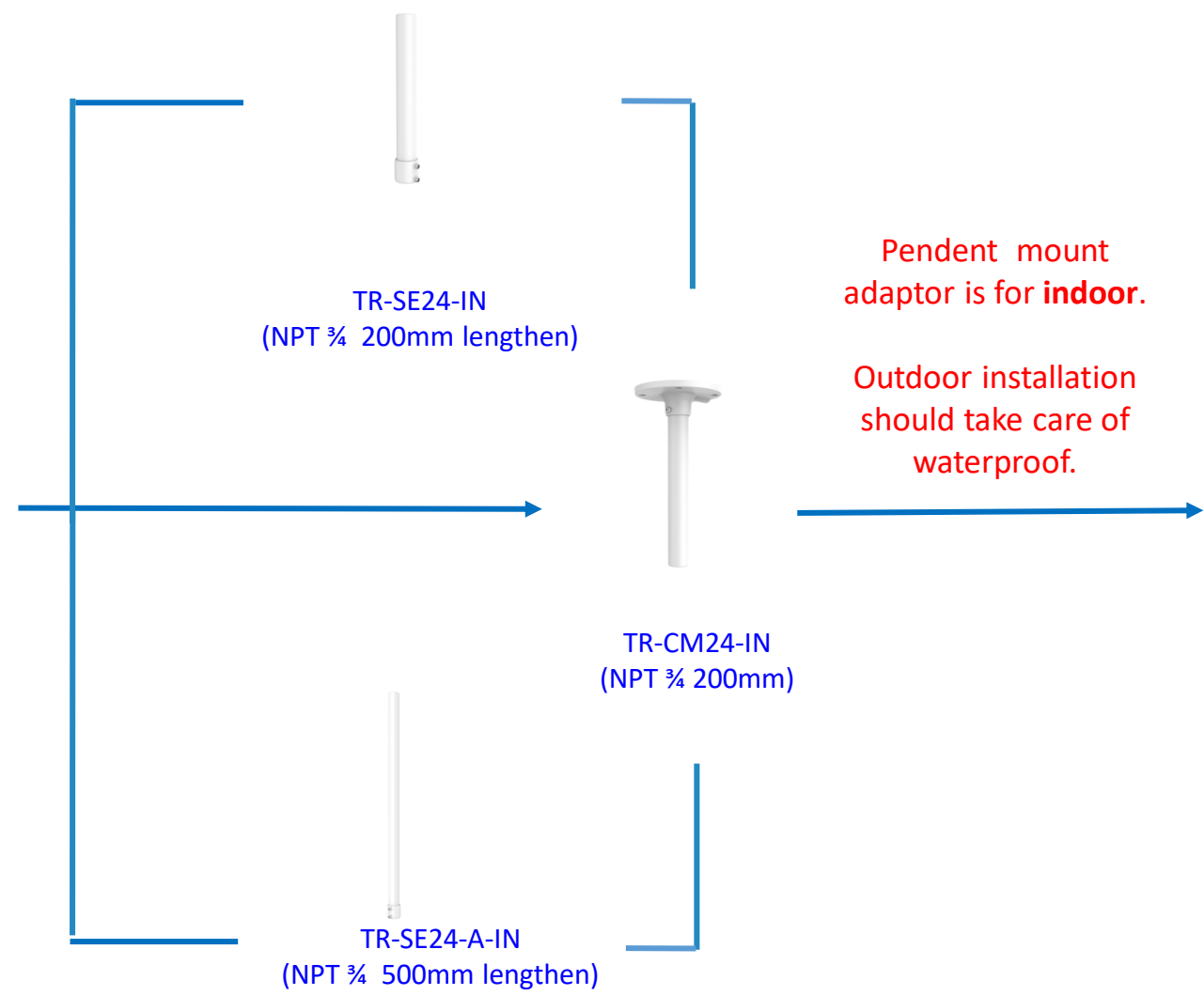

Pendent mount adaptor is for **indoor**.
Outdoor installation should take care of waterproof.

Indoor pendent mount

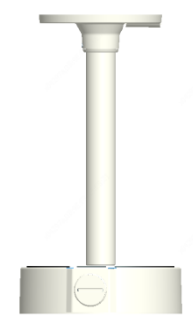

Bullet camera mount



IPC232X/ 222X series



IPC74X series



26X series



IPC252 series

Junction box



TR-JB07-D-IN

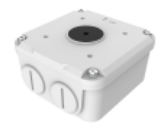

TR-JB06-A-IN

Pole mount



TR-UP06-B-IN

Junction box



TR-JB07-D-IN

Pole mount



TR-UP06-B-IN

NPT 3/4" Plastic Waterproof joint

Optional



TR-A01-IN

Pole mount

Recommended side outlet for cable



TR-UP06-C-IN

NPT 3/4" Plastic Waterproof joint

Optional



TR-A01-IN

Pole mount

Recommended side outlet for cable



TR-UP06-C-IN

Bullet camera mount



IPC2C22

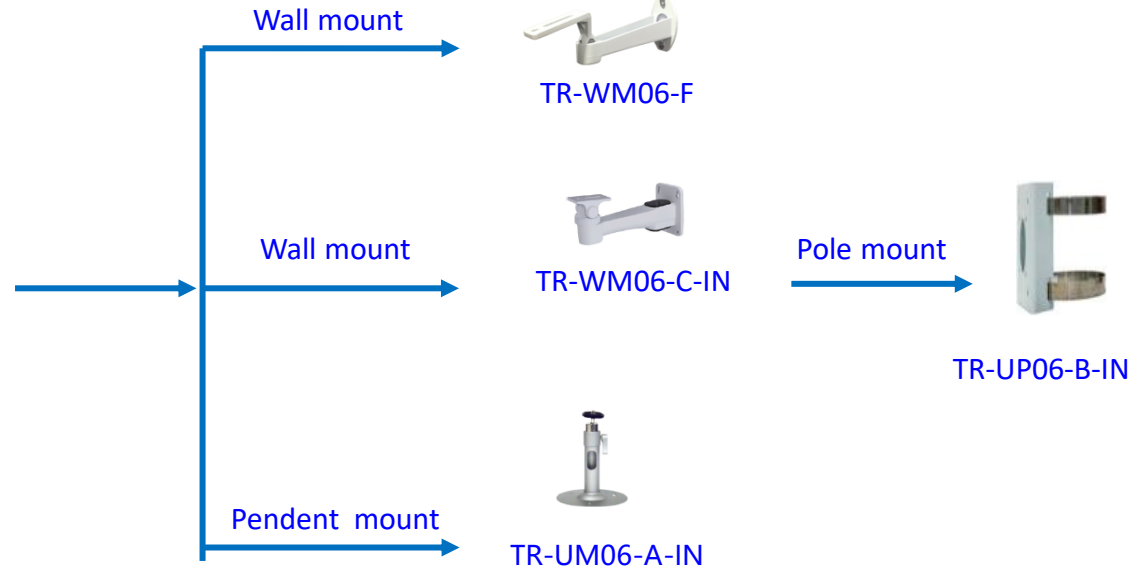

Mini Bullet camera mount

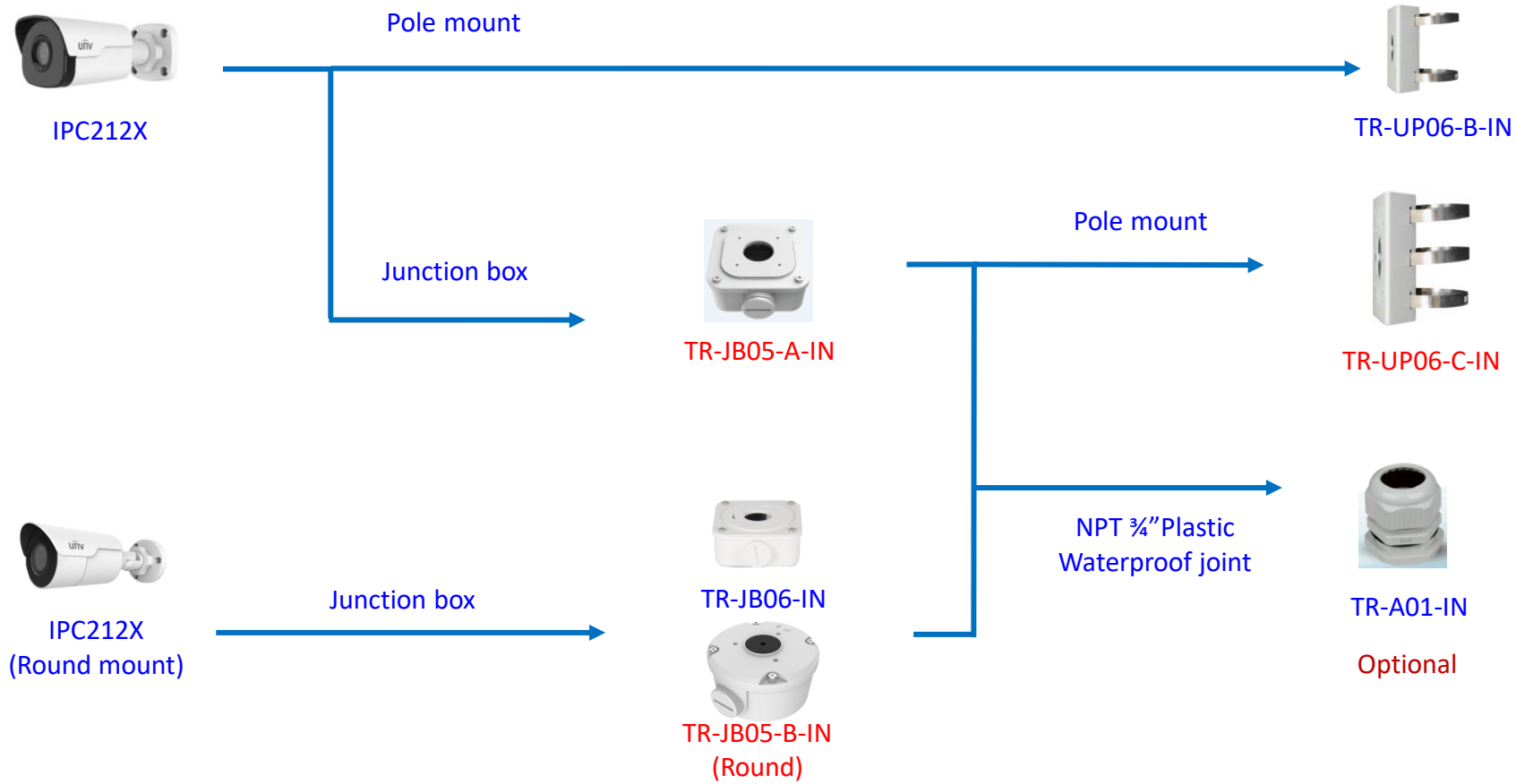

PTZ camera mount



IPC62xx Series
IPC63xx Series

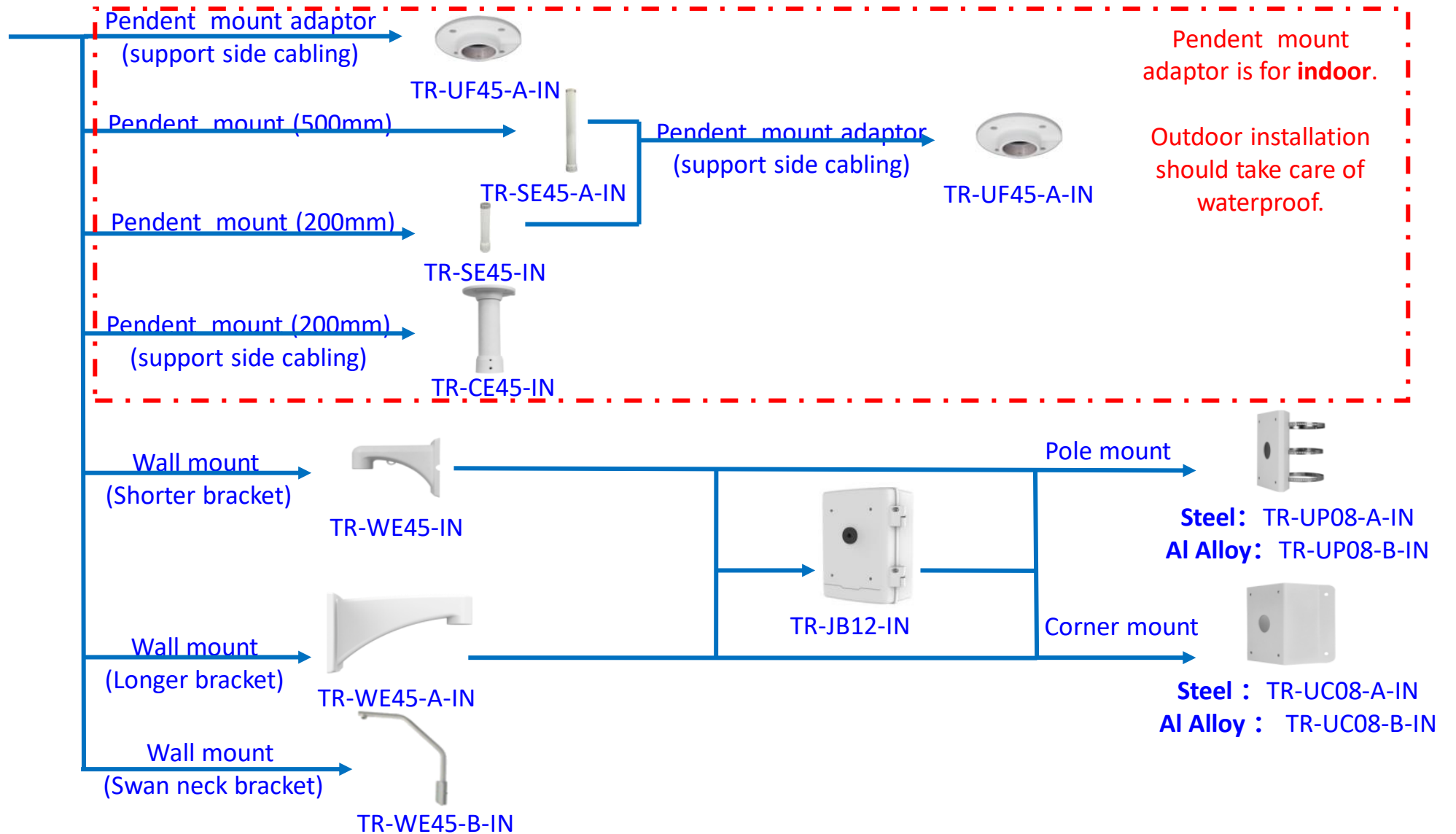

PTZ camera mount

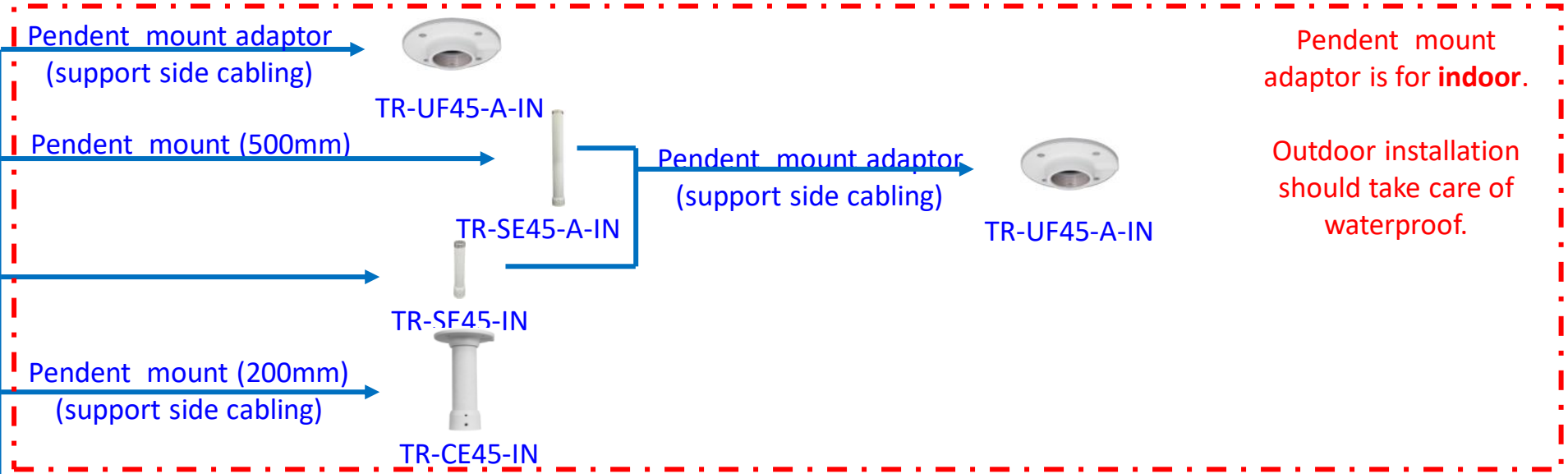

Pendent mount adaptor is for **indoor**.
Outdoor installation should take care of waterproof.

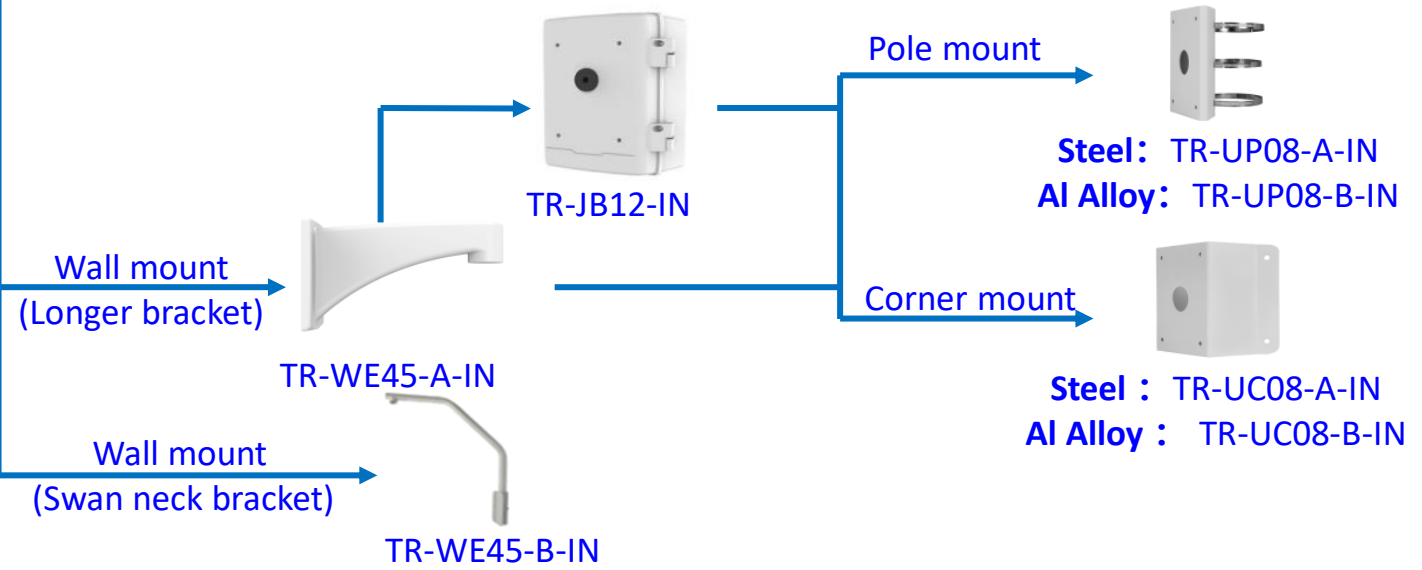

Indoor PTZ camera mount

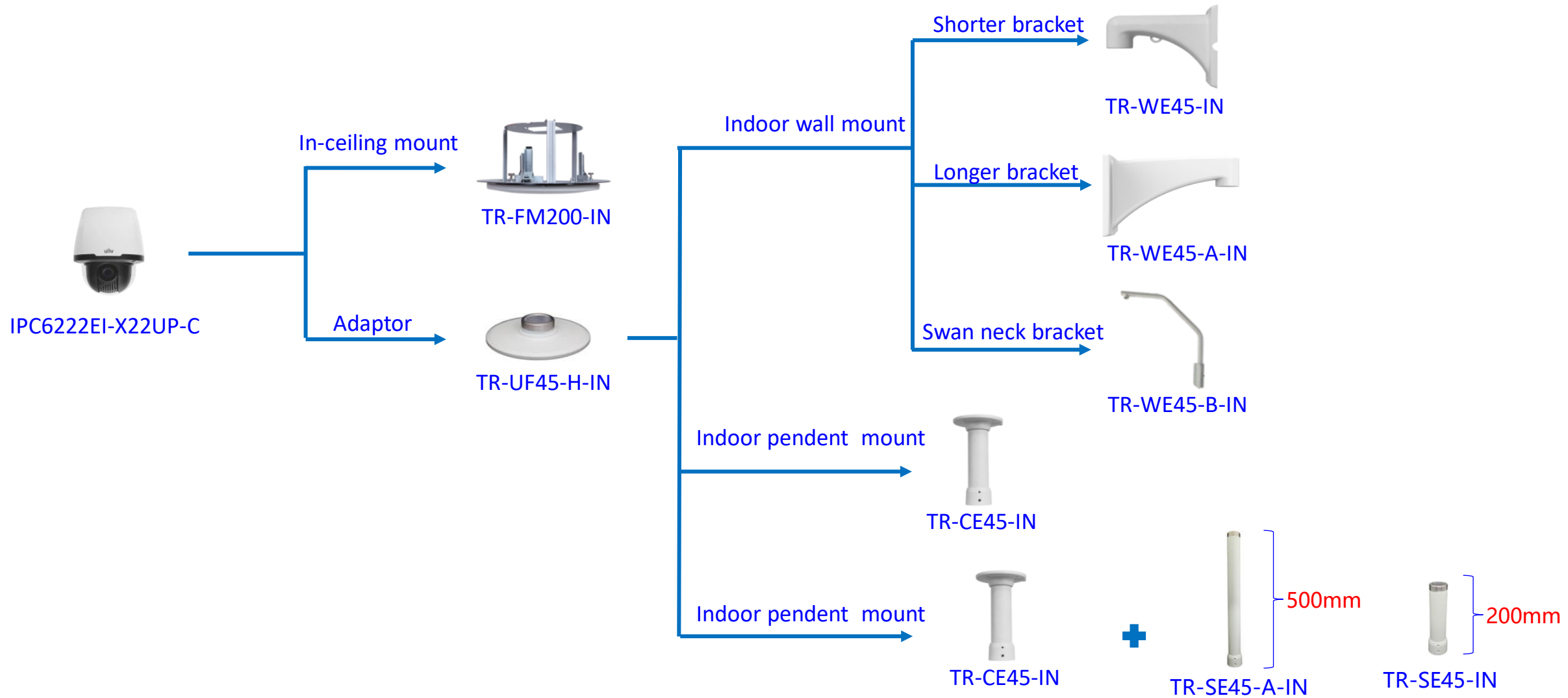

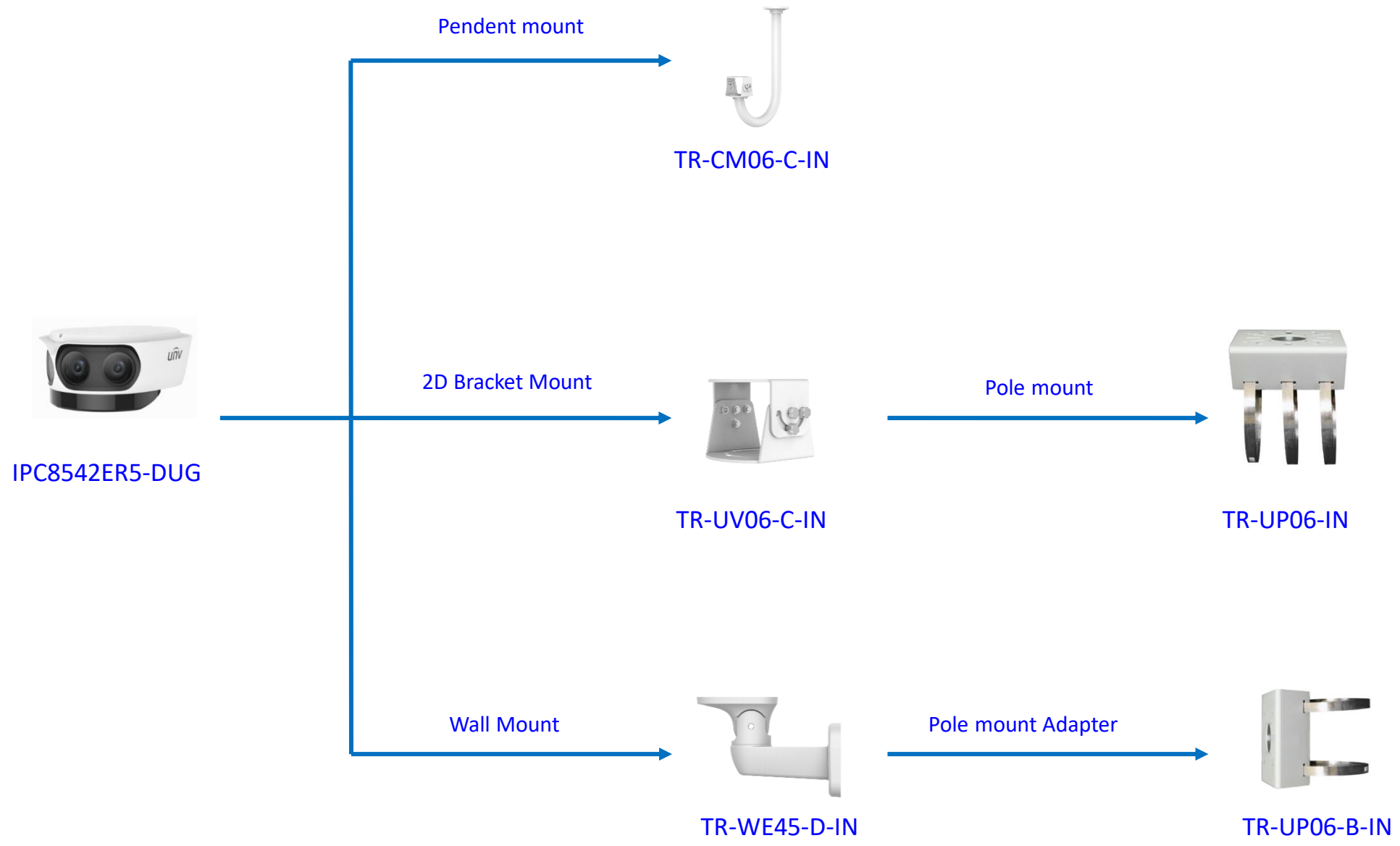

The logo for Uniview, featuring the word "uniview" in a white, lowercase, sans-serif font. A thin white line arches over the "i" and "v". The text is centered within a white graphic element that consists of a horizontal line with rounded ends, forming a shallow U-shape around the text.

uniview